



Ropox SlimLine Electric



User Manual

This manual must always accompany the product.

Table of contents

| | | |
|-------|-------------------------------------|----|
| 1. | Symbols used in this manual | 2 |
| 2. | General safety | 2 |
| 2.1 | Product Unit label | 4 |
| 3. | General requirements | 5 |
| 3.1 | Product information..... | 5 |
| 3.2 | Product description | 5 |
| 3.3 | Intended use | 5 |
| 3.4 | Intended operator | 5 |
| 3.5 | Essential Performance..... | 6 |
| 3.6 | Non-clinical functions..... | 6 |
| 3.7 | Clinical functions..... | 6 |
| 3.8 | Product dimensions | 6 |
| 4. | Instructions for use | 7 |
| 4.1 | Operating the product..... | 7 |
| 4.2 | Installation interfaces..... | 8 |
| 4.3 | Connection adapters..... | 9 |
| 4.4 | Installation of product..... | 10 |
| 4.4.1 | List of components..... | 10 |
| 4.4.2 | Installation of product..... | 12 |
| 4.4.3 | Functionality test..... | 21 |
| 4.5 | Cable diagrams..... | 21 |
| 5. | Trouble shooting | 22 |
| 6. | Safety in use | 22 |
| 7. | Cleaning..... | 23 |
| 7.1 | Preapproved cleaning agents..... | 23 |
| 8. | Maintenance | 23 |
| 8.1 | Performance test | 23 |
| 8.2 | Service schedule | 24 |
| 9. | Spare parts list..... | 25 |
| 10. | Environmental protection | 26 |
| 11. | Electromagnetic compatibility | 26 |
| 11.1 | Suitable Environments..... | 26 |
| 11.2 | Adjacent and stacked use..... | 26 |
| 11.3 | Cables..... | 26 |
| 11.4 | RF portable equipment | 26 |
| 12. | Complaints | 27 |

1. Symbols used in this manual

| | |
|-----------------------------------------------------------------------------------------------------------------------------------------------------------------------------|-------------------------------------------------------------------------------------|
| Warning Symbol Indication of potentially hazardous situation. If not avoided, it can result in serious injury or death. |  |
| Caution Symbol Indication of potentially hazardous situation which may result in minor or moderate injury. It may also be used to alert against unsafe practices. |  |
| Notification Symbol This symbol is used to notify correct use and handling of the product. |  |

2. General safety

| | |
|------------------------------------------------------------------------------------|--------------------------------------------------------------------------------------------------------------------------------------------------------------------------------------------------------------------------------------------------------------------------------------------------------------------------------------------------------------------------------------------------------------------------------------------------------------------------------------------------------------------------------------------------------------------------------------------------------------------------------------------------------------------------------------------------------------------------------------------------------------------|
|  | <p>This manual must be read and understood before use. Always keep this manual in close proximity of the product.</p> <p>The use, installation and service of this product must be in compliance with this manual to avoid accidents and serious personal injury.</p> <p>Never use or handle this product in other ways specified in this manual as it can result in personal safety hazards and/or cause damage to the product.</p> <p>Persons installing and/or using this product either as operator or user should have the necessary safety information and access to this manual.</p> <p>If the supply cord is damaged, it must be replaced by the manufacturer, its service agent or similarly qualified designated persons in order to avoid a hazard.</p> |
|------------------------------------------------------------------------------------|--------------------------------------------------------------------------------------------------------------------------------------------------------------------------------------------------------------------------------------------------------------------------------------------------------------------------------------------------------------------------------------------------------------------------------------------------------------------------------------------------------------------------------------------------------------------------------------------------------------------------------------------------------------------------------------------------------------------------------------------------------------------|



Do not perform repairs, disassembly or assembly operations, add-ons, re-adjustments or modification of the product beyond what is described in this manual. These must be carried out by Ropox or Ropox authorized personnel. Do not perform service while in use.

This appliance can be used by children aged from 8 years and above and persons with reduced physical, sensory or mental capabilities or lack of experience and knowledge if they have been given supervision or instruction concerning use of the appliance in a safe way and understand the hazards involved. Children shall not play with the appliance. Cleaning and user maintenance shall not be made by children without supervision.

Do not use the product if it has defects or have become damaged before being repaired or replaced.
If the control box makes unusual noise or smells, switch off the mains voltage immediately.

Take care that the cables are not damaged.

Unplug the mains cable on mobile equipment before it is moved.

The products must only be used in an environment that corresponds to their IP protection.



The information in this manual is based on correct installation in accordance with installation instructions for this product.

Ropox cannot be held liable if the product is used in any way that differs from stated in this manual and/or installation instruction.

Ropox reserve the right to amend this manual and reference documents without prior notice.

2.1 Product Unit label

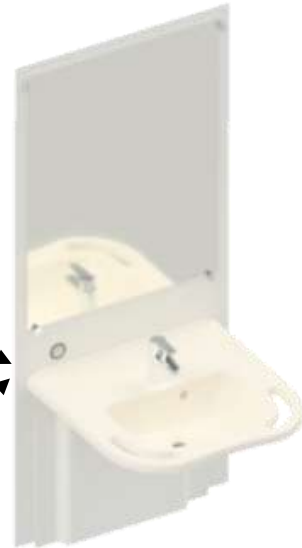
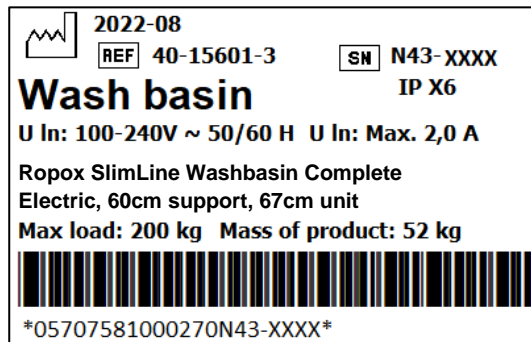

| | |
|--|----------------------------------------------------------------------------------------------------------------------------------------------------------------------------------------------------------------------------------------------------------------|
| | This product is UKCA-marked in accordance with: UK SI 2002 No. 618 - <i>The Medical Devices Regulations 2002</i> , and its amendments |
| | This product is CE-marked in accordance with: European Medical Device Directive 93/42/EEC, including amendments incorporated in Directive 2007/47/EEC. European Medical Device Regulation (EU)2017/745 Council Directive 2011/65/EU, RoHS |
| | Manufacturer name and address |
| | Date of production |
| | Stock number |
| | Serial number |
| | Operating interval of electrically operated equipment. The use of electrical height adjustable equipment can run at maximum 2 minutes, followed by an 18-minute break. |
| | Type BF applied part. The product complies with IEC 60601-1 requirements to provide protection against electric shock. |
| | Consult manual for important safety related information, warnings and safety precautions. |
| | Class II, double isolated electrical components. |
| | Do not dispose as unsorted municipal waste. Product must be returned to a designated recycling station. |
| | Operating and storing temperatures may not exceed 5-40C° |
| | Consult manual before use |

3. General requirements

3.1 Product information

| | | | |
|----------------------------------------------------------|-------------------------------------------------------------------------------------------------------------------------------------------------------------------------------------------------------------|------------------------------|----------------------------------------------------------------------------------------------------------------------------------------------------------------------------|
| Manufacturer | Ropox A/S Ringstedgade 221 DK-4700 Naestved +45 55 75 05 00 Info@ropox.com | UK Responsible Person | Qserve Group UK, Ltd 49 Greek Street, W1D 4EG London United Kingdom +44 740 885 936 3 info@qservegroup.com |
| Product models | Part number | Model | Configuration |
| | 40-15601 | SlimLine Complete | Straight Support Washbasin |
| Expected service life | 5 years | | |
| MDR Class 2017/745 | Class I | | |
| Applied part classification 60601-1 | Type BF applied part | | |
| MEE Class 60601-1 | Class II | | |
| Height adjustment | 70-100cm | | |
| Maximum user weight according to DS/EN 17966:2016 | 200kg | | |
| Power supply | 230V ~50Hz | | |
| I in | Max 2.5A | | |
| Intermittence | 2min use / 18min pause | | |
| IP rating | IPX6 | | |
| Ambient temperature range | -10 °C to +50 °C Transport and storage +5 °C to +45 °C Operation | | |
| Relative humidity: | 20% to 80% - non-condensing | | |
| Intended environments | This product is to be used only in: Professional Healthcare Environment Homecare Environment <i>The device is not intended for use in special environments as defined by IEC 60601-1-2</i> | | |
| Materials in contact with patient | Washbasin | Synthetic/marble composite | |
| | Cover plate | Vacuum-formed acrylic glass | |
| Accessories | 40-15630 | Hand control with holder | |

3.2 Product description

The height-adjustable SlimLine unit is characterized by the elegant and slim design that combines mirror and washbasin into one solution. Ranging from 70-100cm in height adjustment, it offers excellent access for both standing and seated users. In addition, it is designed with plenty of legroom underneath the sink, allowing wheelchair users to come close to the washbasin and within easy reach of the mixer tap.

3.3 Intended use

The SlimLine washbasin combines mirror and basin in one unit, and the mirror is therefore always at the right height no matter if you are sitting in a wheelchair or standing up. You adjust the height with a push on the control switch which is always within reach as it is located right under the mirror.

3.4 Intended operator

Reading and understanding this manual will be sufficient training for an intended operator. Children under the age of 16 or patient are not considered intended operator.

3.5 Essential Performance

The product does not have essential performance, as the patient and user do not experience any risk in case of loss of product function/performance.

3.6 Non-clinical functions

Height adjusting offers better ergonomics to the user.

3.7 Clinical functions

The product does not have any clinical functions.

3.8 Product dimensions

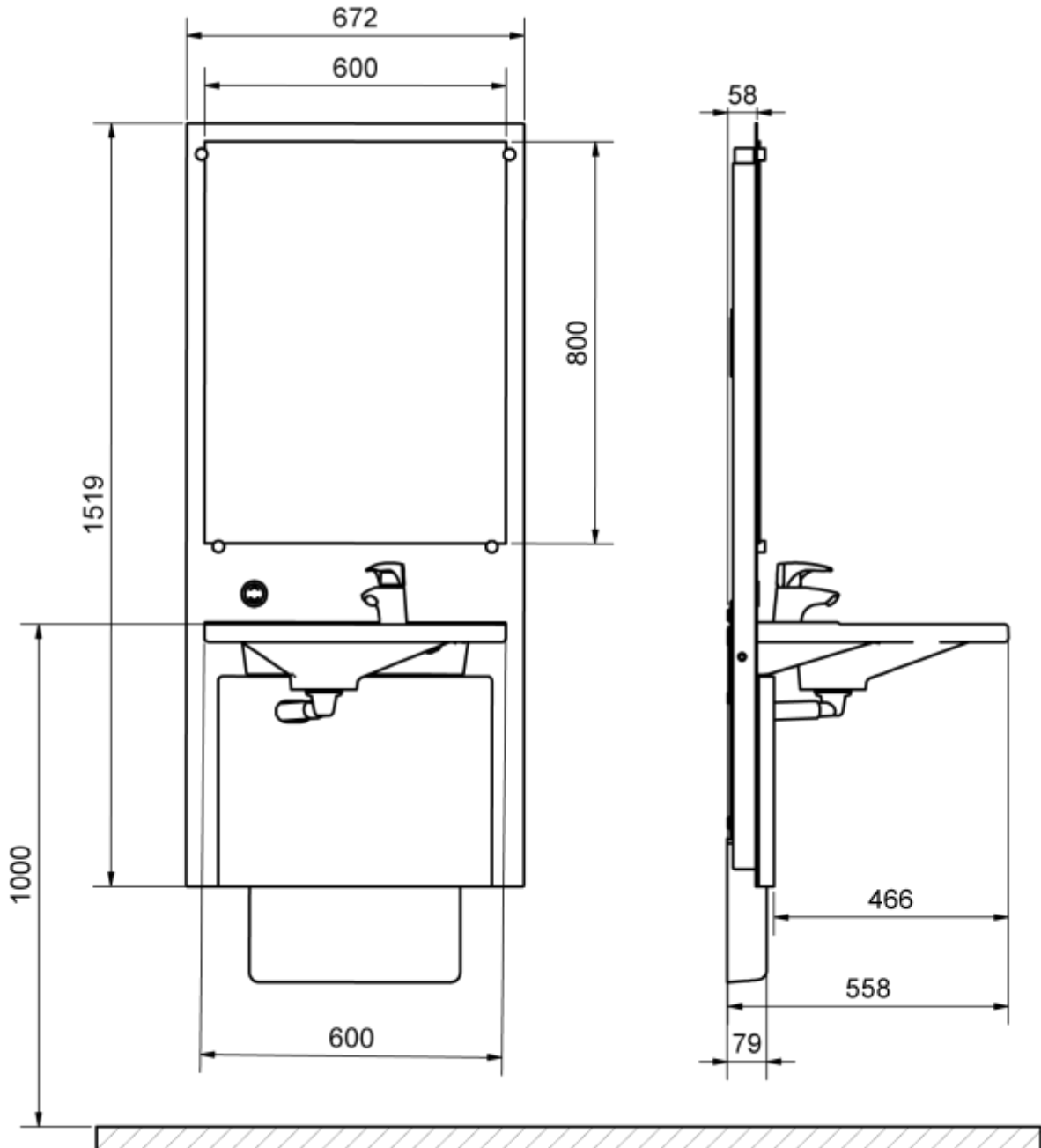

All dimensions in mm

4. Instructions for use

4.1 Operating the product

Ropox SlimLine is adjusted in height by using either the fixed control, or the hand control with spiral cable (accessory). This ensures an optimal height for washing your hands, aiding users and carers alike.

Ropox SlimLine is NOT for use as a lifting table or person lift.

Height adjustment with a fixed standard control

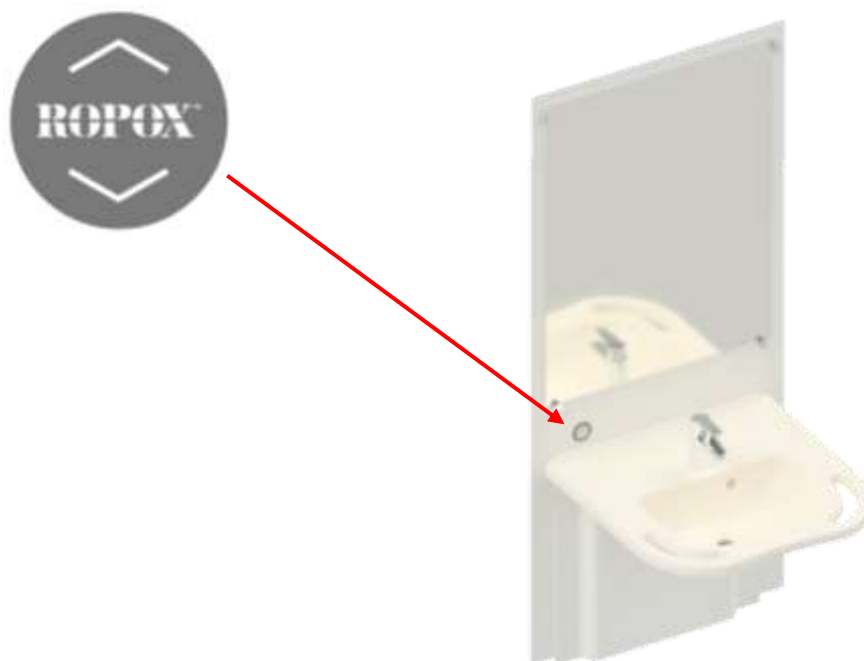

Hand control with spiral cable (available for purchase)



4.2 Installation interfaces

Construction

The wall must be made of a material suited for screw mounting and approved for damp rooms. The hatched area is the minimum area for reinforcement of the wall.

Tested in accordance with DS/EN 12182:2012 and DS/ISO 17966:2016 with the following max. user weights:

40-15601: 165kg (363 lbs)

40-15605: 120kg (265 lbs)

40-15607: 200kg (440 lbs) (when using a porcelain wash basin)

Max. tensile load of upper screws

68kg/screw (150 lbs)

The washbasin is supplied with a set of screws and rawplugs suitable for mounting on a concrete wall. The fitter should always consider the material, condition and strength of the wall and use screws and rawplugs suitable for the specific wall type.

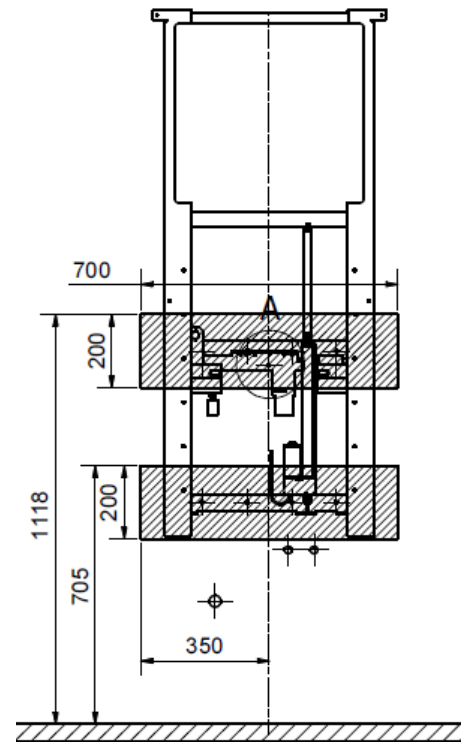

Plumbing

The drain is $\text{Ø}32$ (1 1/4") and ends in an $\text{Ø}32 \times 88.5^\circ$ drain elbow.

The water supply ends in 2 (two) 90° shut-off valves with 1/2" outside thread pointing downwards in an angle of 45° (not included). The maximum protrusion of the shut-off valves and drain connection should be max 77mm (3") to allow for the covers.

The optimum location and orientation are as shown. It is important that all hoses for water connection and drain are flexible to allow the frame to move freely within the height-adjustment range of 700-1000mm (27 1/2" – 39 2/5") (including washbasin). If a different location of water supply from the recommended positioning is required and if there is a floor drain, the installation cover (40-15610) can't be used.

For purchase of adapters for connection to various standard installations, see "Connection Adapters – Other Washbasins".

Power



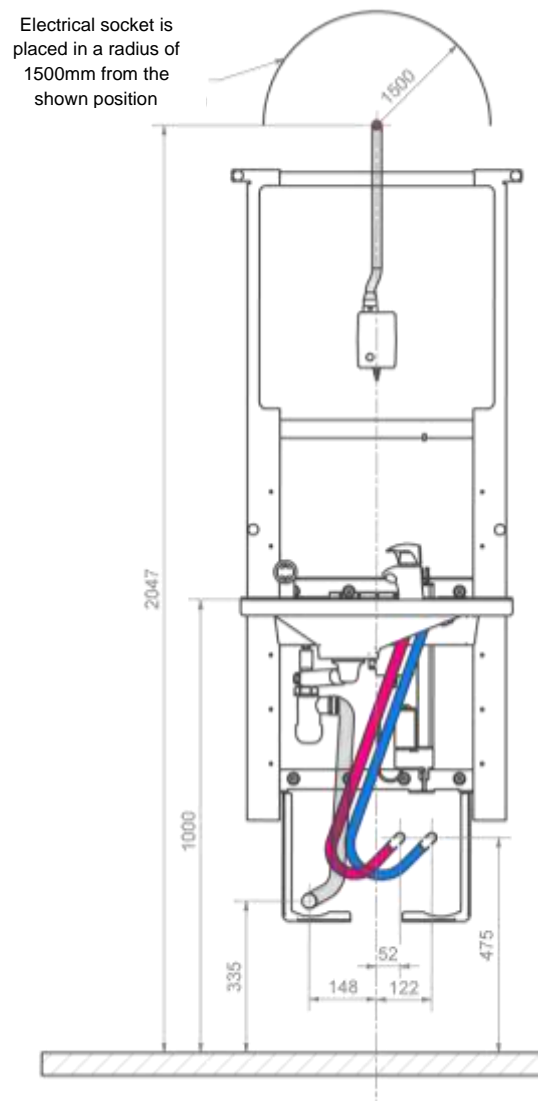



Recommended location of socket in wall for optimum and hidden wiring is above unit as shown. The cable from the control unit is 2000mm (78").







4.3 Connection adapters

If the recommendations cannot be met, the components described below may be ordered. Ropox is not responsible for the optimal functionality of the below components under covers when adjusting the height of the unit.







Water connection adapters

| Hoses from washbasin | Adapter | Installation in room (not included) |
|-------------------------------------------------------------------------------------------|--------------------------------------------------------------------------------------------------------------------------|----------------------------------------------------------------------------------------------------|
|  1/2" | No adapter needed |  1/2" Thread |
| |  1/2" -> 3/8" Item no. 97001670 |  3/8" Thread |
| |  1/2" -> 15mm Item no. 97001666 |  15mm Pipe |





Water hose extensions

| Hose from washbasin | Coupling piece | Extra hose |
|------------------------------------------------------------------------------------|-------------------------------------------------------------------------------------------------------------------------|---------------------------------------------------------------------------------------------------------------------------------------|
|  |  1/2" -> 1/2" Item no. 97001662 |  1/2" x 1/2", 0.5m, steel Item no. 97001123 |
| | |  1/2" x 1/2", 1m, plastic Item no. 97001120 |

Drain adapters

| Drain from washbasin | Adapter | Installation in room (not included) |
|--------------------------------------------------------------------------------------------|--------------------------------------------------------------------------------------------------------------------------|----------------------------------------------------------------------------------------------|
|  Ø32 | No adapter needed |  Ø32 |
| |  Ø32 -> Ø40 Item no. 97001660 |  Ø40 |
| |  Ø32 -> Ø50 Item no. 97001661 |  Ø50 |

Drain extensions

| Drain hose from washbasin | Coupler | Extra drain hose |
|--------------------------------------------------------------------------------------------|---------------------------------------------------------------------------------------------------------------------|---------------------------------------------------------------------------------------------------------------------------------------|
|  Ø32 |  Ø32-Ø32 Item no. 97001662 |  Ø32 Flex hose, 40-110cm Item no. 97001161 |
| | |  Ø32 Flex hose, 27-62cm Item no. 97001162 |





4.4 Installation of product

| | |
|-----------------------------------------------------------------------------------|-----------------------------------------------------------------------------------------------------------------------------------------------------------------------------------------------|
|  | <p>Warning!</p> <p>The product should always be able to travel the full range of actuation without colliding with objects. Failing to do so will compromise the product stability.</p> |
|-----------------------------------------------------------------------------------|-----------------------------------------------------------------------------------------------------------------------------------------------------------------------------------------------|

| | |
|-----------------------------------------------------------------------------------|------------------------------------------------------------------------------------------------------------------------------------------------------------------------------------|
|  | <p>Warning!</p> <p>The fitter should always consider the material, condition and strength of the wall and use screws and rawlplugs suitable for the specific wall type.</p> |
|-----------------------------------------------------------------------------------|------------------------------------------------------------------------------------------------------------------------------------------------------------------------------------|

Prior to the installation, make sure that all parts have been provided in accordance with the list of components.

4.4.1 List of components

| | | | |
|--------------|--------------------|----|---------------------------------------------------------------------------------------|
| 40*15601-040 | Lifting unit | 1x |  |
| 97002454 | Mirror 600x800x5 | 1x |  |
| 40*15601-084 | Cover top | 1x |  |
| 40*45601-062 | Cover bottom | 1x |  |
| 40-15610 | Installation cover | 1x |  |
| 97002671 | Actuator | 1x |  |

| | | | |
|---------------------|-----------------------------------------|----|---------------------------------------------------------------------------------------|
| 97002674 | Fixed control | 1x |  |
| 97002672 | Control box | 1x |  |
| 97002679 | Power supply | 1x |  |
| 97002680 | AC cable 2m | 1x | |
| 97001706 | Oras Saga 3910F | 1x |  |
| 40-15612-0 | Plumbing kit SlimLine | 1x |  |
| <i>Incl.</i> | | | |
| 97001601 | Prevex siphon | 1x | |
| 97001162 | Flexible drain hose Ø32/32 pipe | 1x | |
| 97001035 | 32x88,5° white PP Wafix elbow HT | 1x | |
| 97001126 | Connection hose 700mm, Lindner | 2x | |
| 97001605 | Prevex 100mm extension | 1x | |
| 95091070 | Plate screw Ø4,8x70 cross recess A2 | 1x | |
| 40*15601-100 | Mounting parts SlimLine frame | 1x | |
| <i>Incl.</i> | | | |
| 95027578 | Frame screw 7,5x72 stainless | 8x | |
| 95027576 | Zebra "shark" dowel 10x61 | 8x | |
| 95125035 | Chipboard screw 5x35 | 3x | |
| 40-44170-1 | Mirror bracket | 1x | |
| 96000170 | Strips black 4,8/290mm | 4x | |
| 40*15601-021 | Mounting bracket | 1x | |
| 95061290 | Bolt M12x90 | 2x | |
| 95170512 | Chamfered washer M12 | 2x | |
| 97001467 | Mounting parts for Ifö Spira 60 | 1x | |
| 40*15601-095 | Spacer | 8x | |
| 95020521 | CSK INSEX screw M5x20 | 4x | |
| 97001582 | 60 cm Straight Support Washbasin | 1x |  |

4.4.2 Installation of product

The maximum tensile load of the screws is 68 kg. The wall must be able to resist such tensile load.

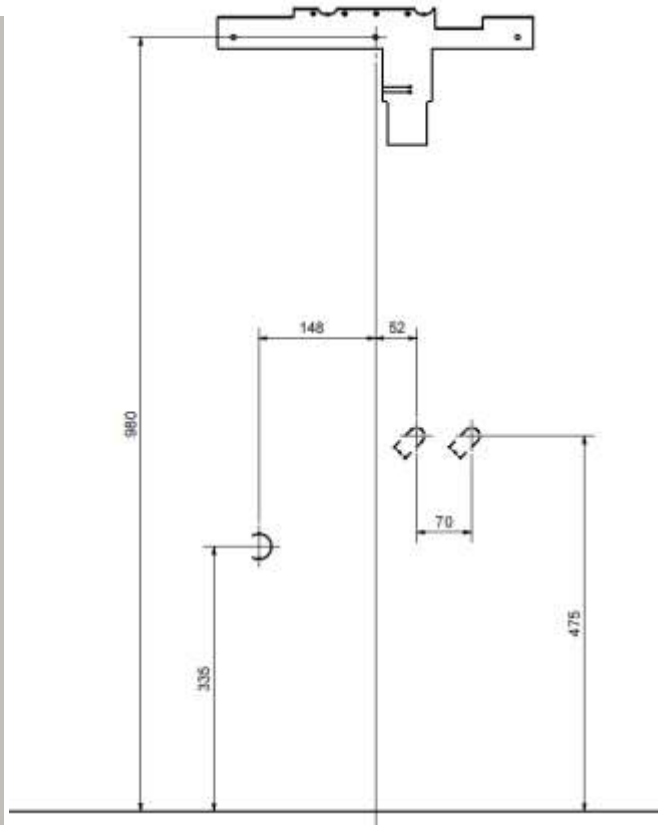
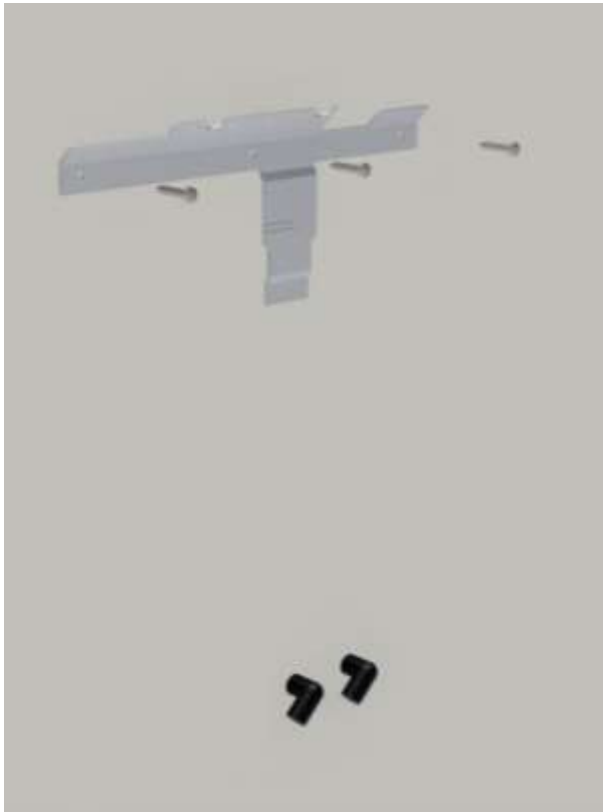

Fix the mounting bracket as illustrated on the drawing with the right distance to water and drain.
Make sure that the mounting bracket is level.



M12 bolts mount from behind,
before mounting the frame on the
wall

Hang the lifting unit on the mounting bracket.
Make sure to put the M12 bolts for the washbasin in the frame prior to mounting.

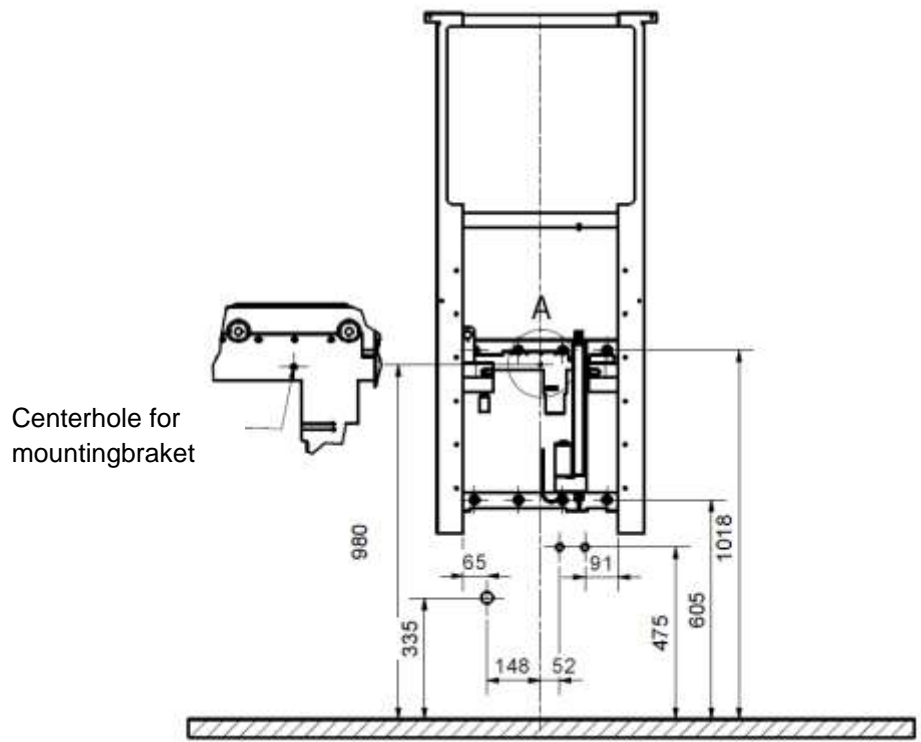

Place the unit in accordance with the water connection and drain as shown on the drawing.



Push 8 spacers in behind the frame so that it has the right distance to the wall.
Mark the 8 holes for fastening. Take the lifting unit down again and drill the holes in the wall.



Use suitable rawlplugs and screws for the mounting.

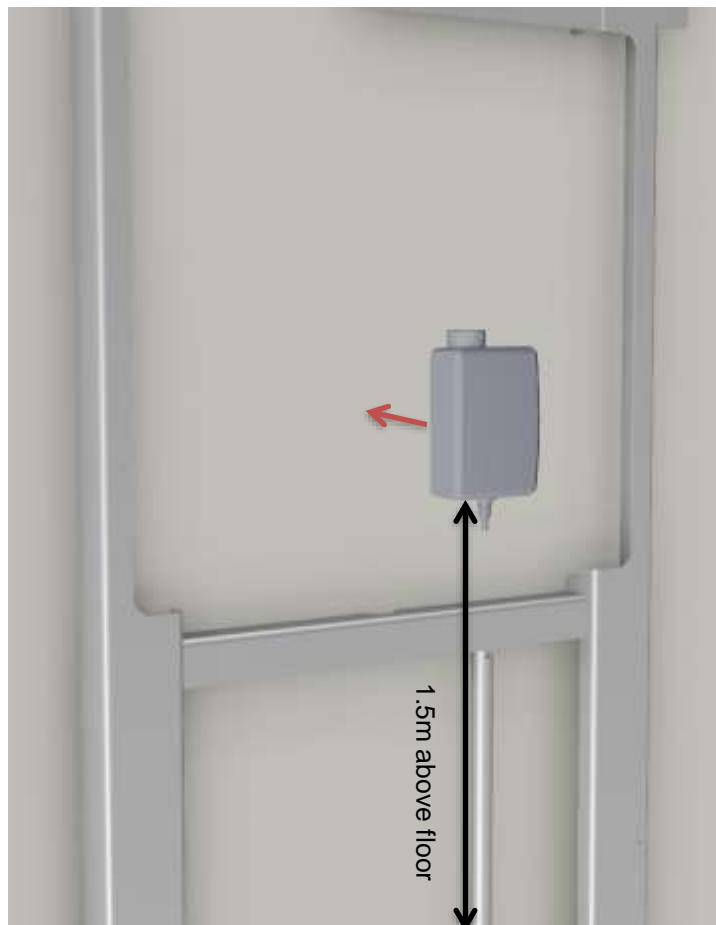

Remove the protective foil on the tape and fasten the power supply above the unit. Locate 1.5 m above the floor measured on the underside. Place it in the middle of the lifting unit.

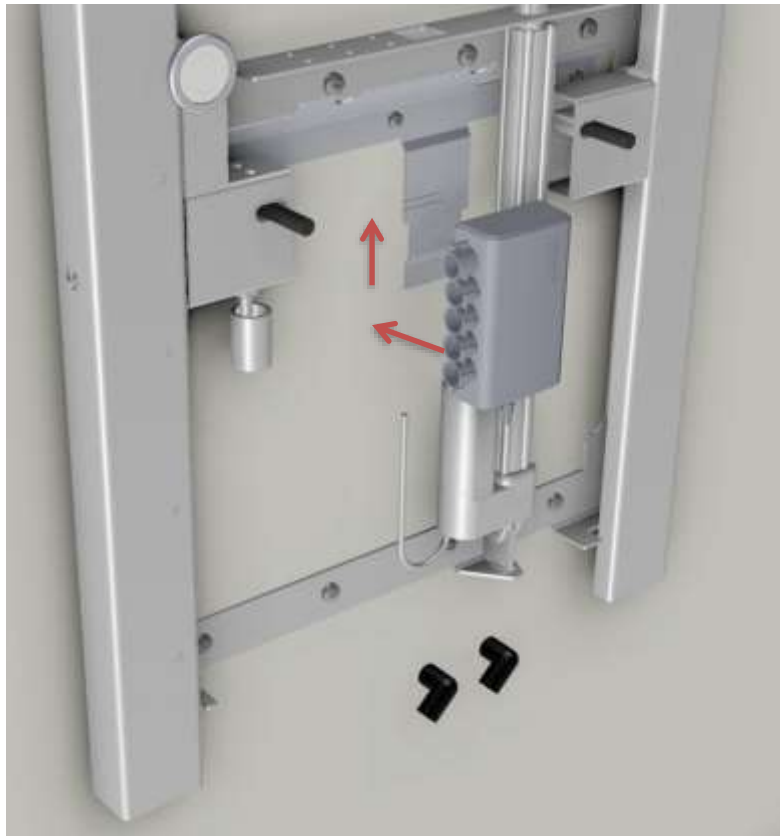

Mount the control box on the mounting bracket. Make sure that the small aluminium leg interlocks and locks the box in a fixed position.

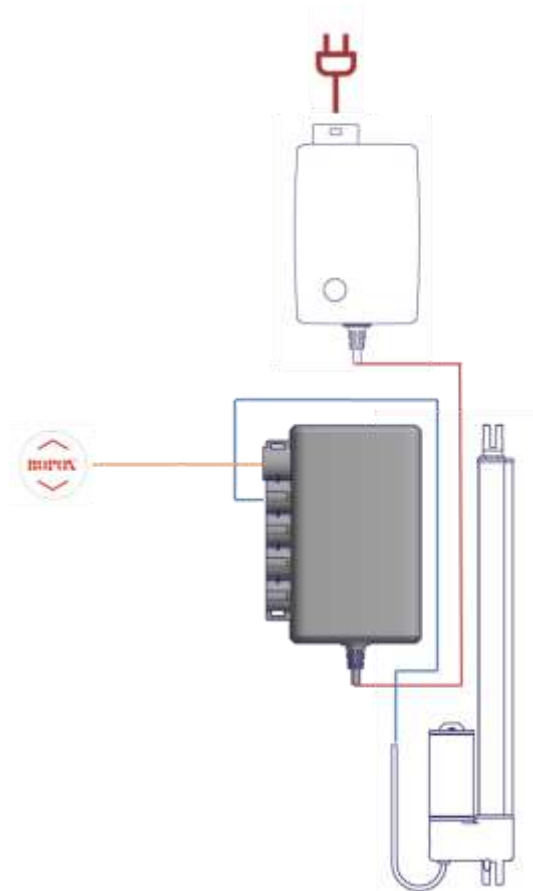



Connect the electrical system as illustrated. Fix the excess cable from the power supply on the mounting bracket with strips.
Check that the unit freely moves at up/down. If needed, use cable clips etc. for the power cable.



Fix the rods for the mirror bracket in the frame with M5 countersunk screws.

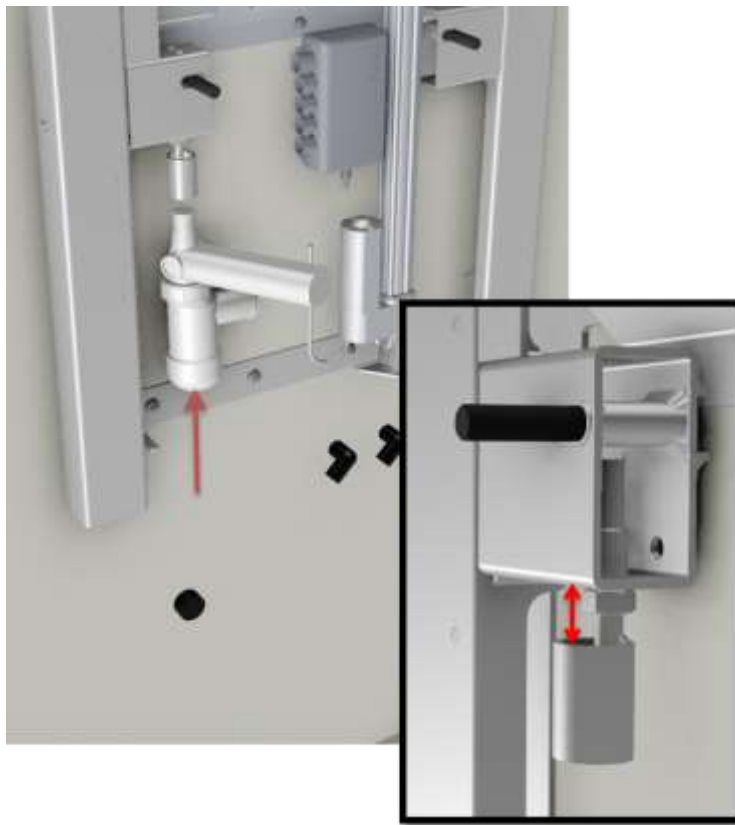

Install the siphon. Adjust the holder bracket to 20mm.



Mount the flat cover and 3 (three) mirror brackets so it is kept in.

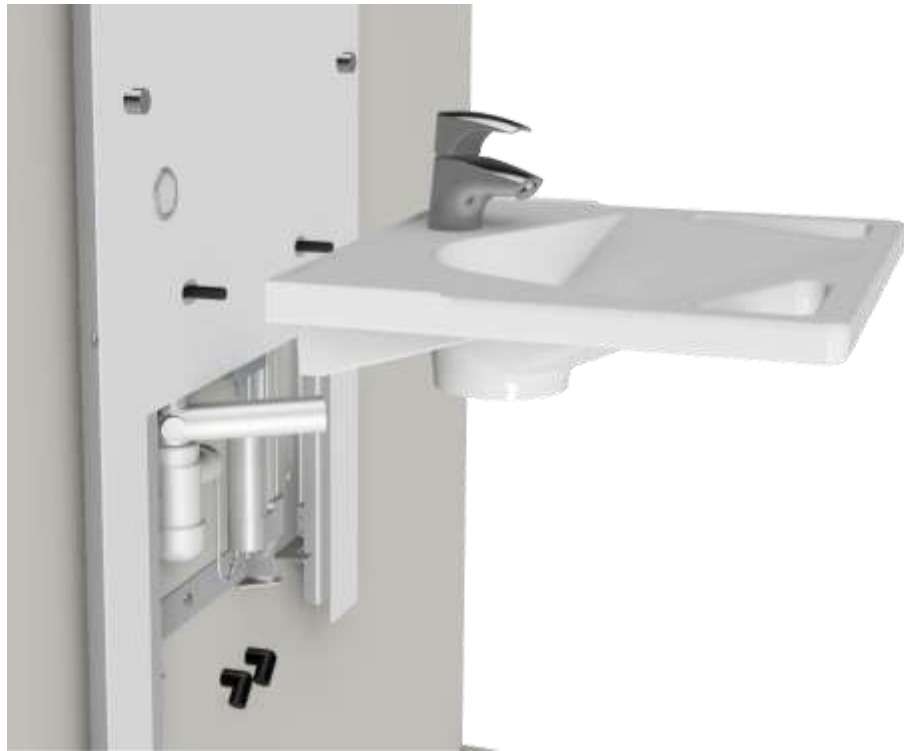

Now mount the washbasin with the enclosed mounting parts for bolt mounted washbasins.



Caution!

When mounting a porcelain washbasin, an insulation foam pad **MUST** be placed between the washbasin and the unit. It is recommended to grout around the washbasin.



Remove the protective foil from the double-coated tape on the back of the brackets for the installation cover.

That is now pushed in place so that the brackets glue to the wall.



Remove the installation cover and push the brackets very firmly against the wall to make sure that the glue has good contact with the wall.

The power connection is positioned in a radius of up to 1500mm

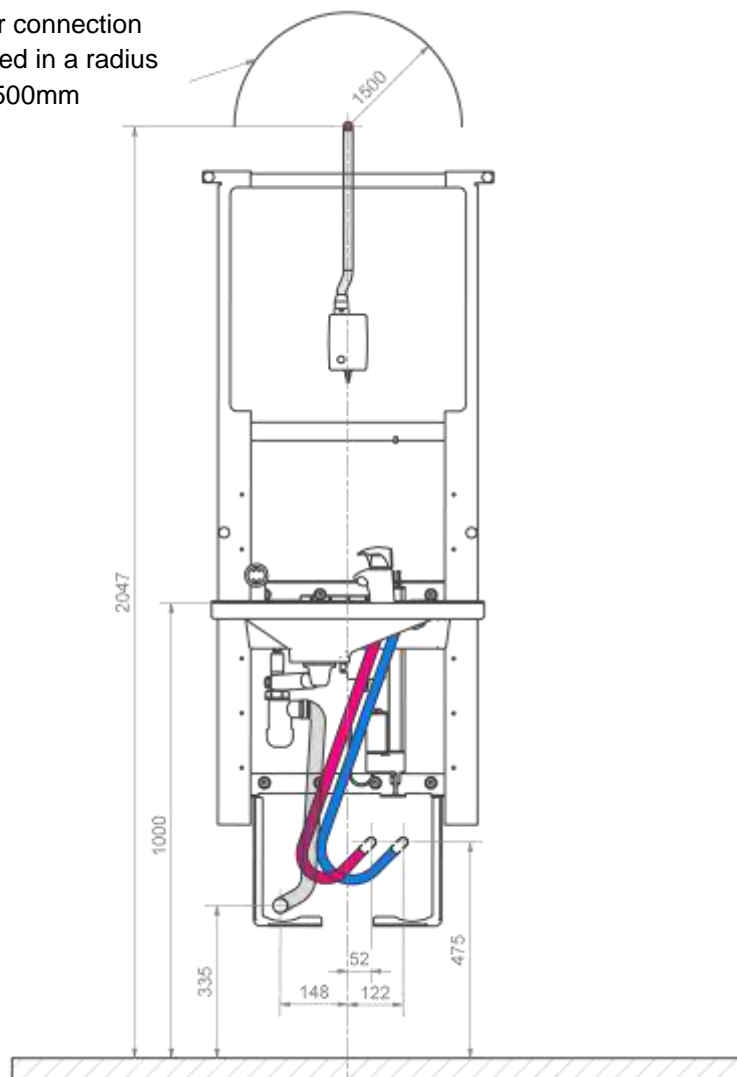

Install water connection and drain hoses as illustrated. Put the installation cover back on. Make sure that all hoses move freely and unhindered.



Put the outermost cover on as illustrated.



Install the rest of the drain and screw it in the washbasin.
Now check that the washbasin and hoses below the caps move freely by moving the lifting unit up and down.



Remove the protective foil on the double-coated tape on the back of the mirror and fix it as illustrated.
Press it firmly and make sure that the mirror is properly fastened so that the final mirror bracket can be mounted.

4.4.3 Functionality test

After installation has been completed, and before putting the product into use, it's important to test the functionality of the Ropox SlimLine. Afterwards, it's important to conduct the same functionality test once a year to ensure continued safe use. This must be done by qualified persons only.

1. Check that the mounting instructions have been properly followed.
2. Check that all the nuts/bolt/screws are properly fastened.
3. Check that the plumbing is connected properly and doesn't leak.
4. Make sure the frame is not under external stress, such as colliding with objects.
5. Make sure the frame and washbasin doesn't collide with anything during travel. Do a full travel of the frame to ensure proper function, and check for colliding objects.

Afterwards, the Ropox SlimLine can be put into use. Before the first use, read section 6 Safety in Use.

4.5 Cable diagrams

Standard product with fixed control.

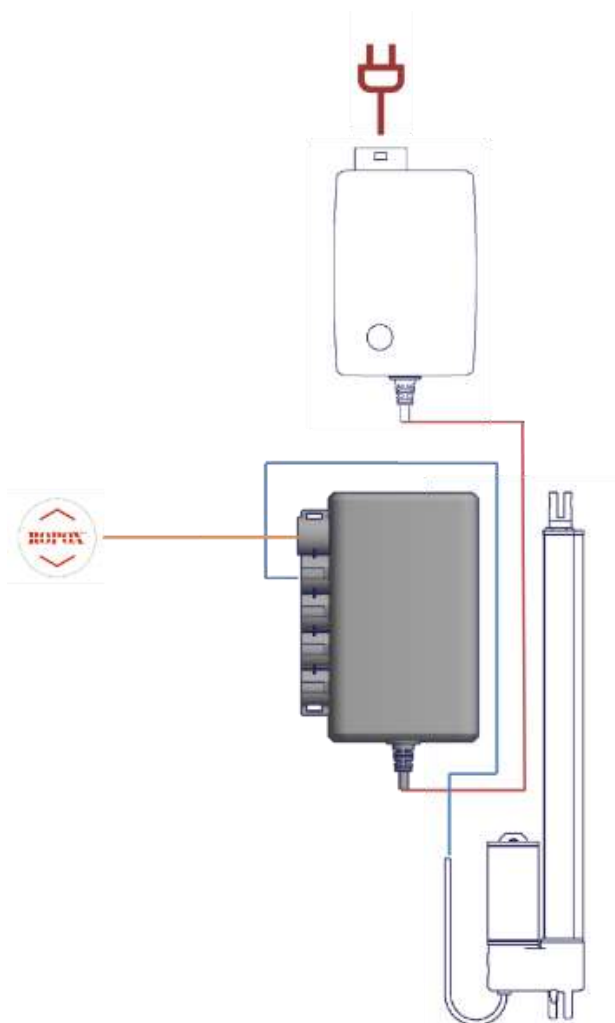

Product with fixed control and handheld control. Here, a split cable is used.

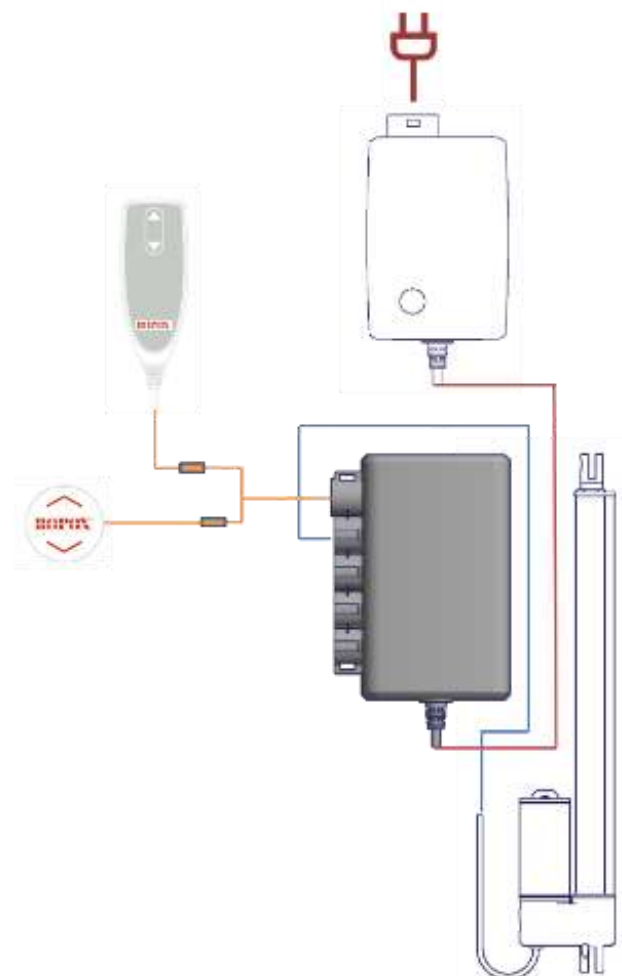

5. Trouble shooting

| Problem | Solution |
|-------------------------------------------------------------------------------------------------------|----------------------------------------------------------------------------------------------------------------------------------------------------------------------------------------------------------------------------------------------------------------------------------------------------------------------------------------------------------------------------|
| The washbasin does not move up or down when pressing the hand control. | Check if: <ul style="list-style-type: none"> ➤ 230 V is connected, and if the power is on. ➤ The engine is connected to the control box. ➤ The control is connected to the control box. ➤ The engine is overloaded. (NOTE: For every 2 minutes of use, it needs 18 minutes of rest). |
| Hand control is defect. | Check if: <ul style="list-style-type: none"> ➤ The washbasin can be height adjusted by means of another control. |
| When pressing the UP and DOWN buttons, only "click" sounds come out of the control box – no movement. | <ul style="list-style-type: none"> ➤ The plug may not be mounted correctly. ➤ Remove all cables from the control box, and mount again. ➤ Maybe a "Reset" is needed. See the instructions below. |
| The frame seems loose and unstable. | <ul style="list-style-type: none"> ➤ Tighten all screws of the frame, cf. the mounting instructions. |
| The washbasin cannot be height adjusted, or the height adjustment feels very difficult. | <ul style="list-style-type: none"> ➤ Check that there are no jammed objects preventing the height adjustment. |
| It takes too long for the water to leave the washbasin. | <ul style="list-style-type: none"> ➤ Check the siphon for clogging and clean it, if required. ➤ Check that the flexible hose has not been positioned so high on the wall that it acts as an additional siphon. ➤ Check that connection hoses are not kinked or twisted on the hose. Adjust the hoses so that they are not kinked/twisted. |

Reset: Press and hold the UP (▲) and DOWN (▼) buttons at the same time. Keep the buttons depressed for approx. 10 seconds. Now move the frame to bottom position for resetting.

6. Safety in use

- Always use the washbasin in a manner excluding the risk of damage to people or property. The person operating the SlimLine washbasin is responsible for avoiding damage or injury.
- The SlimLine washbasin is a height adjustable washbasin and may not be used as a lifting table or as a person lifter.
- Always check the water temperature before use. Too warm water may lead to scalding.
- If a handcontrol with flexible cord has been installed, be aware of the cord not getting caught on anything. This could lead to a tripping hazard.
- Make sure that there is free space above and below the washbasin to allow free height adjustment.
- Be aware of water splashing from the washbasin during use, or actuation of the height adjustment. A wet floor will result in a slipping hazard.
- Prior to use, ensure that the SlimLine washbasin has been mounted on a suitably strong wall and that there are no loose connections.
- Make sure that there are no people under the SlimLine when adjusting the height
- Do not overload the washbasin and make sure that the load distribution is correct.
- Do not operate the washbasin in case of errors or damage.
- Do not use the washbasin in an explosive environment.
- If covers are removed there is a risk that a person can place fingers/hands between moving parts (actuator) and fixed parts (metal frame).
- If the mirror breaks or falls out of the holders, then a person may be hit by sharp, broken parts.
- If the washbasin is used in publicly accessible locations, where especially children or other persons with reduced observation capability may get near the SlimLine washbasin, the person operating the washbasin must pay sufficient attention in order to prevent dangerous situations.
- Any modification to the SlimLine washbasin, which may influence its operation and construction, is forbidden.
- Installation, service, and repairs may only be conducted by qualified personnel.
- If the SlimLine washbasin has not been installed in accordance with these mounting instructions, the warranty may be void.
- Only use original Ropox spare parts as replacements parts. If other parts are used, the warranty may be void.

7. Cleaning

Ropox SlimLine may be wiped with a wrung cloth with lukewarm water and a mild detergent. Do not use corrosive/grinding fluids or scouring sponges.

| | |
|-----------------------------------------------------------------------------------|----------------------------------------------------------------------------------------------------------------------------------------------------------------------------------------------------------------------------------------------------------------------|
|  | Note! |
| | Do not use cleaning agents containing abrasive e.g. scouring powder, steel wool, scouring sponge. This product is not designed to be sterilized, autoclaving and sterilization beyond normal cleaning is may possibly change the product safety and function. |

7.1 Preapproved cleaning agents

| Tradename | Solution |
|----------------------|----------------------|
| Acticlor plus | 1000ppm |
| S90 sanirens | 1-3% peracid |
| FUTUR, Alkalisk rens | 1% solution [pH 9,5] |

8. Maintenance

| | |
|------------------------------------------------------------------------------------|-------------------------------------------------------------------------------------------------------------------------------------------------------------------------------------|
|  | Note! |
| | Failing to comply with periodic maintenance may result of degrading of product function and safety. Inspections, service and repairs must be carried out by competent personnel. |

The frame of the Ropox Slimline Electric is maintenance-free. Moving parts have been lubricated for life. For reasons of safety and reliability, we recommend inspection of the frame once a year.

8.1 Performance test

After one month

Check:

Mounting of fixtures

The connection of the flexible hoses – water supply and drain

Once a year

Move the washbasin to top position and check:

- That all screws and bolts are fixed.
- That the frame can move freely and unhindered from bottom to top position without problems.
- That water connection hoses and drain hoses are tight and functional and able to move unhindered.
- Press the DOWN (▼) button, move the frame to bottom position and check that the movement is even and smooth. Make sure that the hose connections follow the movements of the frame, and that they do not get squeezed.
- Now press the UP (▲) button, move the frame to top position and check that the movement is even and smooth. Make sure that the hose connections follow the movements of the frame, and that they do not get squeezed.

After each inspection, the service schedule must be completed. See section 8.2.

| | |
|-------------------------------------------------------------------------------------|--------------------------------------------------------------------------------------------------------------|
|  | Note! |
| | Only use original Ropox spare parts as replacement parts. If other parts are used, the warranty may be void. |

8.2 Service schedule

| |
|--------------------------------------------------|
| Service and maintenance Serial no. |
| Date: _____ |
| Signature: _____ |
| Remarks: _____ _____ _____ |

| |
|--------------------------------------------------|
| Service and maintenance Serial no. |
| Date: _____ |
| Signature: _____ |
| Remarks: _____ _____ _____ |

| |
|--------------------------------------------------|
| Service and maintenance Serial no. |
| Date: _____ |
| Signature: _____ |
| Remarks: _____ _____ _____ |

| |
|--------------------------------------------------|
| Service and maintenance Serial no. |
| Date: _____ |
| Signature: _____ |
| Remarks: _____ _____ _____ |

| |
|--------------------------------------------------|
| Service and maintenance Serial no. |
| Date: _____ |
| Signature: _____ |
| Remarks: _____ _____ _____ |

| |
|--------------------------------------------------|
| Service and maintenance Serial no. |
| Date: _____ |
| Signature: _____ |
| Remarks: _____ _____ _____ |

| |
|--------------------------------------------------|
| Service and maintenance Serial no. |
| Date: _____ |
| Signature: _____ |
| Remarks: _____ _____ _____ |

| |
|--------------------------------------------------|
| Service and maintenance Serial no. |
| Date: _____ |
| Signature: _____ |
| Remarks: _____ _____ _____ |

9. Spare parts list



Note!

Ropox will make parts list available for extraordinary maintenance and repair beyond what is described in this manual. Repair beyond what is described in this manual may only be done by Ropox designated service personnel.

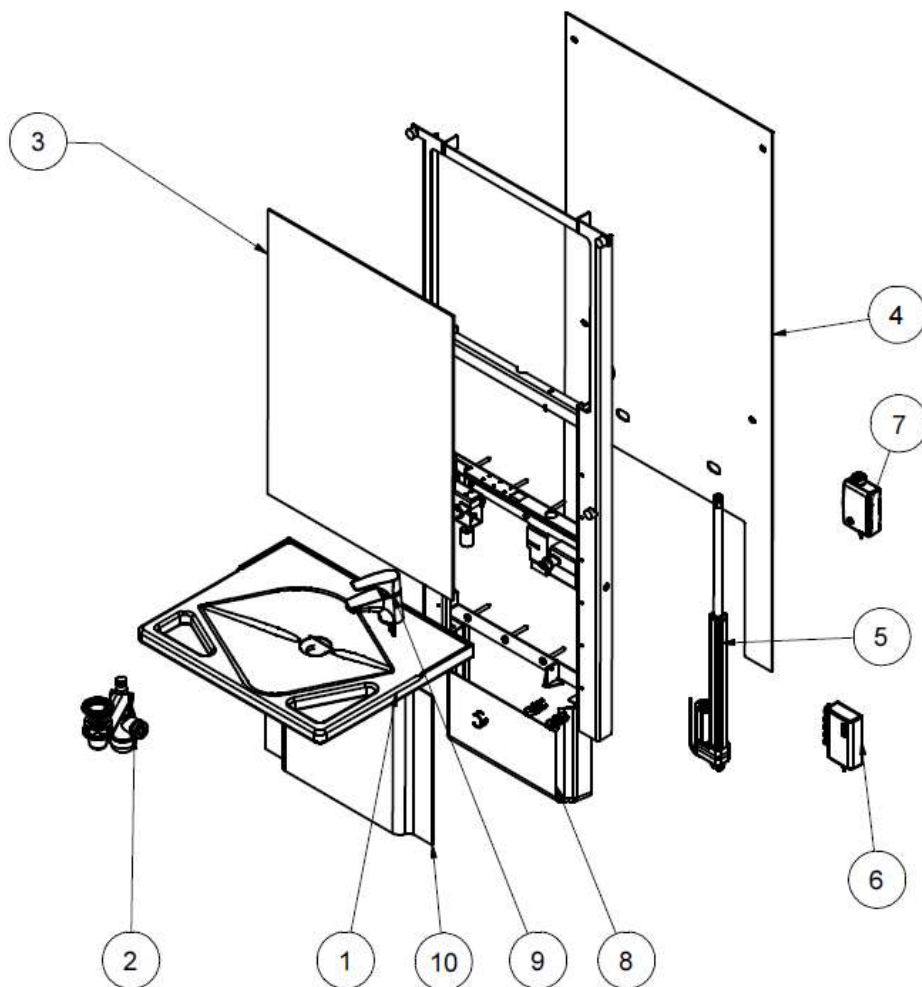

| Position | Description | Number in product | Item no. |
|----------|----------------------------------|-------------------|--------------|
| 1 | 60 cm straight support washbasin | 1 | 97001582 |
| 2 | Plumbing kit for SlimLine | 1 | 40-15612 |
| 3 | Mirror 600x800x5 | 1 | 97002454 |
| 4 | Top cover | 1 | 40*15601-084 |
| 5 | Actuator | 1 | 97002671 |
| 6 | Control box | 1 | 97002672 |
| 7 | Power supply | 1 | 97002679 |
| 8 | Installation cover | 1 | 40-15610 |
| 9 | Oras Saga 3910F | 1 | 97001706 |
| 10 | Bottom cover | 1 | 40*15601-062 |
| 11 | Control | 1 | 97002674 |

10. Environmental protection

The product is not intended to be disposed as municipal waste. Proper disassembly, sorting and disposal of components must be done by waste disposal professionals.



| Part | Disposal recommendation |
|-------------|-------------------------|
| Wash basin | Ceramic |
| Main unit | Steel |
| Faucet | Steel |
| Cover | Plastic |
| Actuator | Electronic |
| Control box | Electronic |

11. Electromagnetic compatibility

11.1 Suitable Environments

The device is suitable for use at home, at daycare centers, at day centers for persons with physical or mental disabilities or at hospitals except near active HF surgical equipment and the RF shielded room of a medical electrical system for magnetic resonance imaging, where the intensity of electromagnetic disturbances is high.

11.2 Adjacent and stacked use

| | |
|--|------------------------------------------------------------------------------------------------------------------------------------------------------------------------------------------------------------------------------------------------------------------------------------------------|
| | <p>Warning!</p> <p>Use of this equipment adjacent to or stacked with other equipment should be voided because it could result in improper operation. If such use is necessary, this equipment and the other equipment should be observed to verify that they are operating normally</p> |
|--|------------------------------------------------------------------------------------------------------------------------------------------------------------------------------------------------------------------------------------------------------------------------------------------------|

11.3 Cables

| Cable component | Length |
|---------------------------|------------------------|
| Power cable | 3,2m |
| Hand control spiral cable | Approx. 90cm extended. |

| | |
|--|--------------------------------------------------------------------------------------------------------------------------------------------------------------------------------------------------------------------------------------------------------------------------------------------|
| | <p>Warning!</p> <p>Use of accessories, transducers, and cables other than those specified or provided by the manufacturer of this could result in increased electromagnetic emissions or decreased electromagnetic immunity of this equipment and result in improper operation.</p> |
|--|--------------------------------------------------------------------------------------------------------------------------------------------------------------------------------------------------------------------------------------------------------------------------------------------|

11.4 RF portable equipment

| | |
|--|----------------------------------------------------------------------------------------------------------------------------------------------------------------------------------------------------------------------------------------------------------------------------------------------------------------------------------------------|
| | <p>Warning!</p> <p>Portable RF communications equipment (including peripherals such as antenna cables and external antennas) should be used no closer than 30 cm (12 inches) to any part of the device, including cables specified by the manufacturer. Otherwise, degradation of the performance of this equipment could result.</p> |
|--|----------------------------------------------------------------------------------------------------------------------------------------------------------------------------------------------------------------------------------------------------------------------------------------------------------------------------------------------|

12. Complaints

See General Terms of Sale and Delivery on www.ropox.com

UK
CA

CE

ROPOX A/S

Ringstedgade 221

DK – 4700 Næstved

Tel.: +45 55 75 05 00 Fax.: +45 55 75 05 50

E-mail: info@ropox.dk

www.ropox.com